

English Ready

22636VIC Course in Initial EAL

VU23493 Recognise, copy and use numbers and money from 1 to 50

Numbers

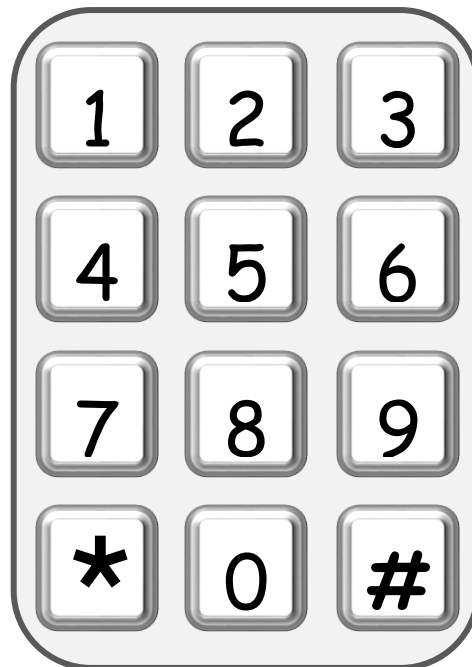

Name _____

Teacher _____

Class _____

Date _____

This workbook is designed to be used with the support of a teacher.

Design team: Vicki Hambling, Sue Paull, Frida Dean, Glenise Kleehammer and Mary Wallace

Illustrations: Madelena Scott

Image acknowledgements

Australian Currency designs – Permission granted by the Royal Australian Mint, Approval # 9/45/432

Balloons - [This Photo](#) by Unknown Author is licensed under [CC BY-NC](#)

Australian coat of arms [This Photo](#) by Unknown Author is licensed under [CC BY-SA](#)

Acknowledgements: The design team would like to thank the AMEP service providers and practitioners who participated in the trial and gave valuable feedback. The team would also like to acknowledge the use of the EAL Framework which underpins the design of this book.

Copyright of the EAL Framework is reserved to the Crown in the right of the State of Victoria. © State of Victoria (Department of Education and Training) 2023.

This English Ready Resource is licensed under a Creative Commons Attribution-NoDerivs 3.0 Australia licence (More information is available [here](#)). You are free to use, copy and distribute to anyone in its original form as long as you attribute Department of Home Affairs as the author and you license any derivative work you make available under the same licence.

© Commonwealth of Australia 2023



With the exception of the Commonwealth Coat of Arms, the department's logo, any material protected by a trade mark and where otherwise noted all material presented in this document is provided under a Creative Commons Attribution 4.0 International (<https://creativecommons.org/licenses/by/4.0/>) licence.

The details of the relevant licence conditions are available on the Creative Commons website (accessible using the links provided) as is the full legal code for the CC BY 4.0 licence. (<https://creativecommons.org/licenses/by/4.0/legalcode>).

Use of all or part of this document must include the following attribution:

© Commonwealth of Australia 2023

As far as practicable, material for which the copyright is owned by a third party will be clearly labelled. The department has made all reasonable efforts to ensure that this material has been reproduced in this document with the full consent of the copyright owners.

Copyright requests and enquiries concerning usage not addressed by the CC BY 4.0 licence should be addressed to: comms@homeaffairs.gov.au at the Department of Home Affairs.

The terms of use for the Commonwealth Coat of Arms are available from the [It's an Honour](#) website.

Where a copyright owner, other than the Commonwealth, is identified with respect to this material, please contact that third party copyright owner directly to seek permission.

Table of contents

1	Instructions	1
2	Meet the students and teachers.	2
3	Trace and copy numbers.....	3
4	Numbers 1 - 10	7
5	Numbers 1 - 12	21
6	Numbers 1 - 20.....	25
7	Numbers 1 - 30.....	29
8	Numbers 1 - 50.....	33
9	My numbers.....	45

1 Instructions



1.



listen

2.



say

3.



copy

4.

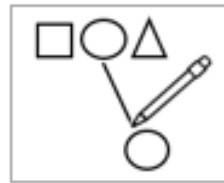

match

5.



colour

6.

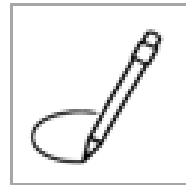

circle

7.



read

8.



trace

9.



point

10.



clap

2 Meet the students and teachers.



Students



1. Zarni



2. San



3. Jamila

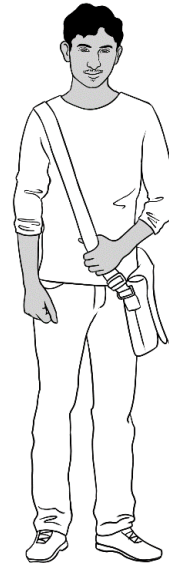

4. Rahim



5. Ming

Teachers



6. Rosie



7. Wendy



8. Peter

3 Trace and copy numbers.

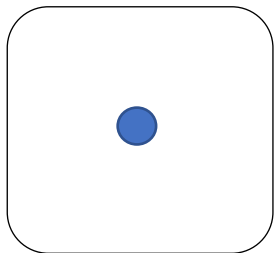
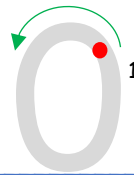
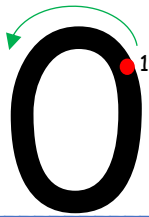
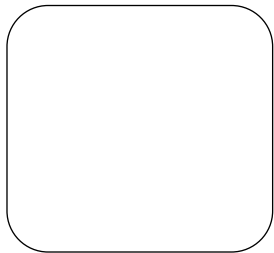

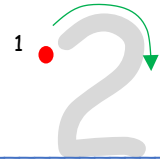
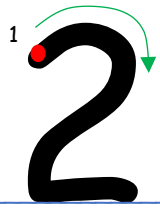
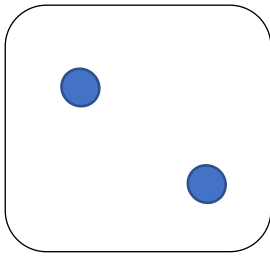

2 2 2 2 2 2 2

2

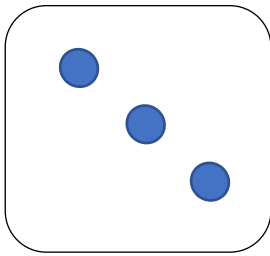

3 3 3 3 3 3 3

3

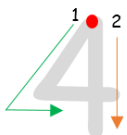
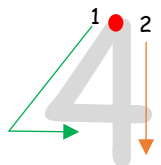
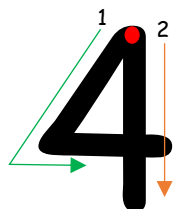
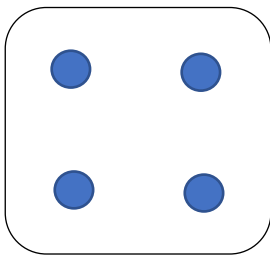

4 4 4 4 4 4 4

4

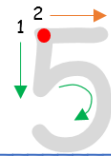
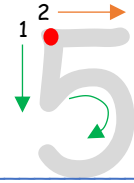
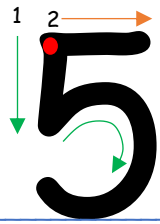
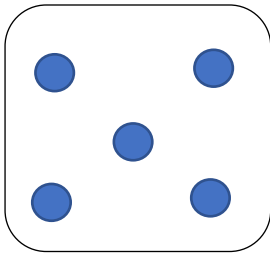

5 5 5 5 5 5 5

5

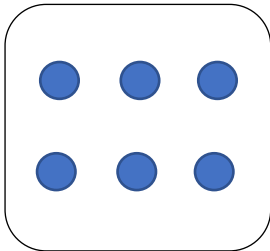

6 6 6 6 6 6 6

6

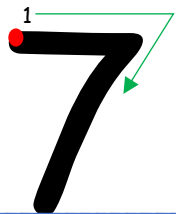
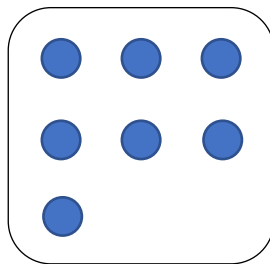

7 7 7 7 7 7 7

7

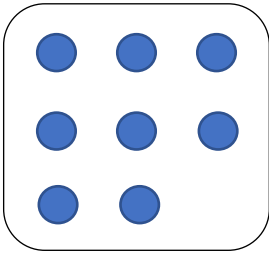

8 8 8 8 8 8 8

8

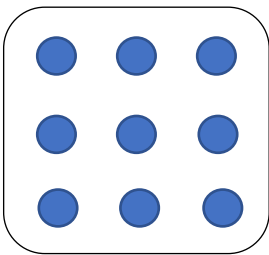

9 9 9 9 9 9 9

9

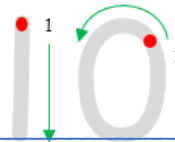
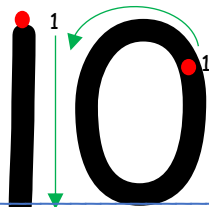
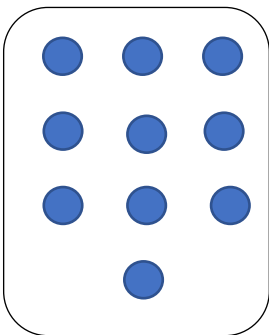

10 10 10 10 10 10 10

10

4 Numbers 1 - 10



How many apples?



0	
1	
2	
3	
4	
5	
6	
7	
8	
9	
10	

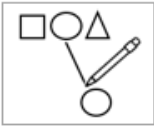

0	
1	
2	
3	
4	
5	
6	
7	
8	
9	
10	

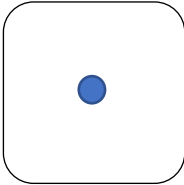
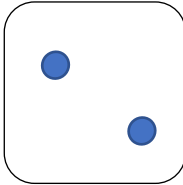
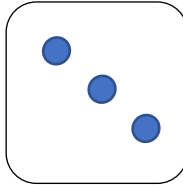
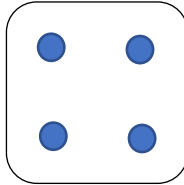
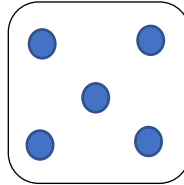

1	2	3	4	5
				
1				

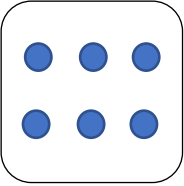
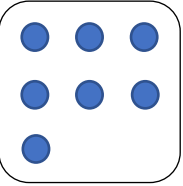
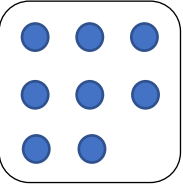
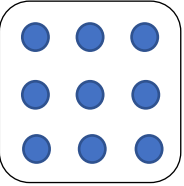
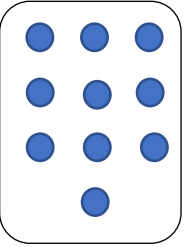
				
6	7	8	9	10

1.  

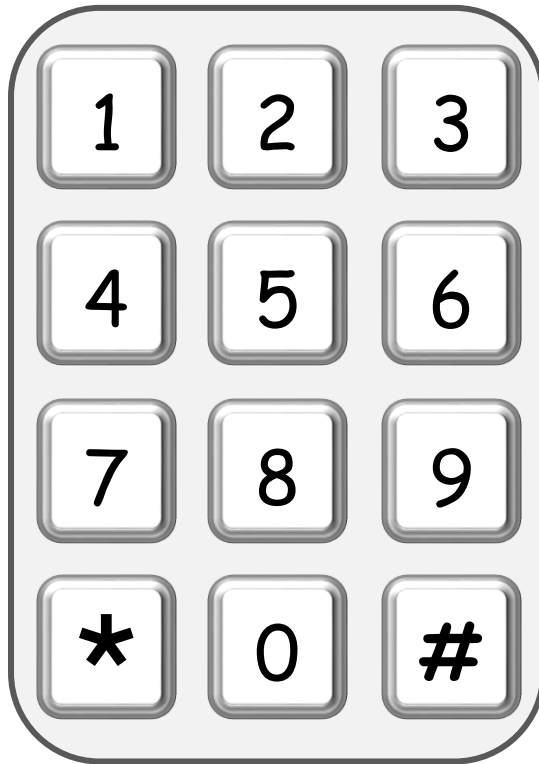

2.  

1	2	3	4	5
6	7	8	9	10



How many dollars?



\$1

one dollar



\$2

two dollars



\$5

five dollars



\$10

ten dollars

1.



\$2

\$10

\$1

\$5

2.



\$1	\$2	\$5	\$10
\$	\$	\$	\$



+



\$2

\$ 2



+



\$3

\$



+



\$4

\$



\$5

\$



+



\$6

\$











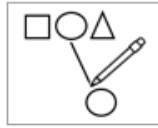



+



\$7

\$



1.		+	
2.		+	
3.		+	
4.			
5.		+	
6.		+	

\$3

\$5

\$2

\$7

\$4



\$6

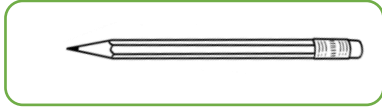

What is number 1?

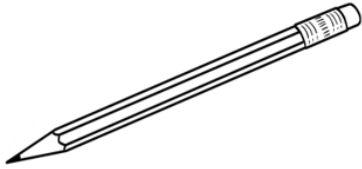
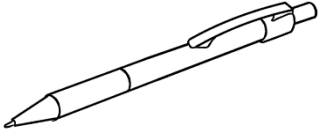
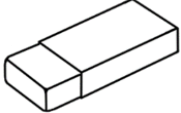

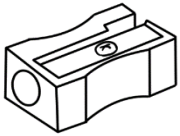
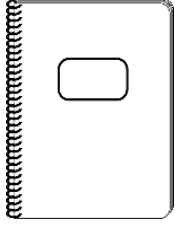

<p>1.</p>  <p>pencil</p>	<p>2.</p>  <p>pen</p>	<p>3.</p>  <p>rubber</p>
---	---	---

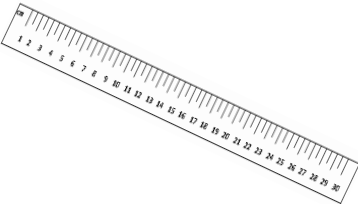
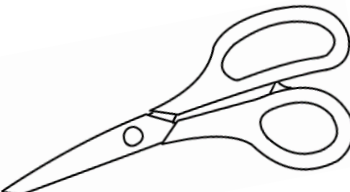
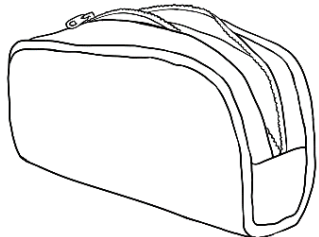
<p>4.</p>  <p>sharpener</p>	<p>5.</p>  <p>notebook</p>	<p>6.</p>  <p>glue</p>
--	---	---

<p>7.</p>  <p>ruler</p>	<p>8.</p>  <p>scissors</p>	<p>9.</p>  <p>pencil case</p>
--	--	--

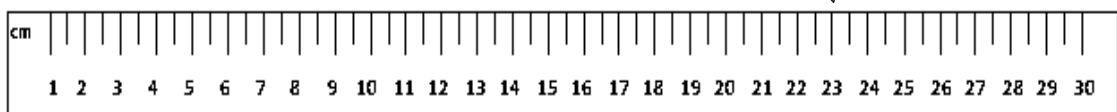
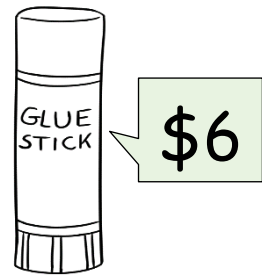
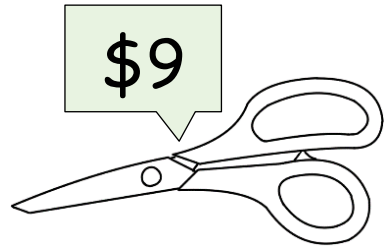
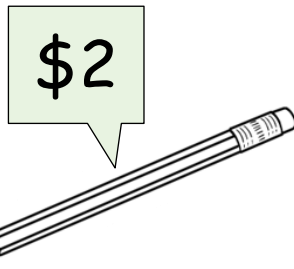
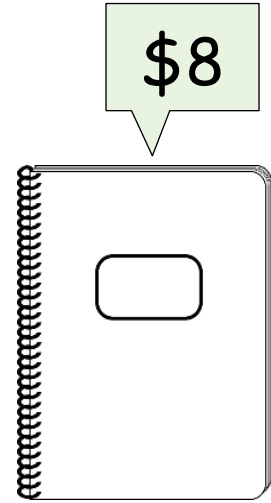
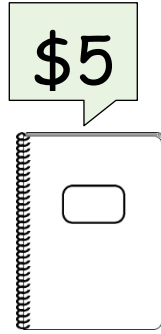
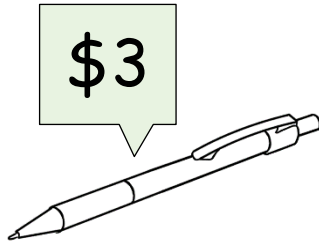
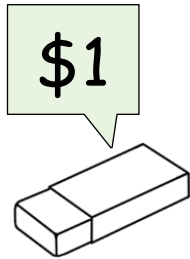

Pen and Pencil Shop



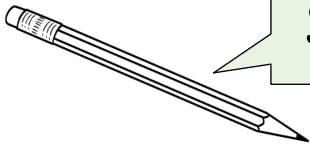
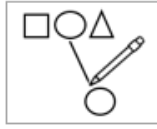

\$2



\$3

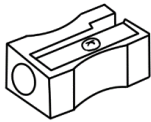

\$4

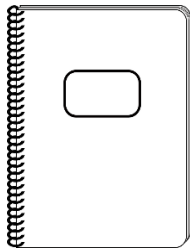

\$5

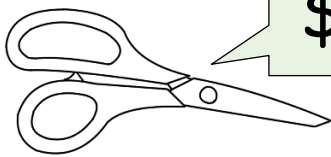

\$9

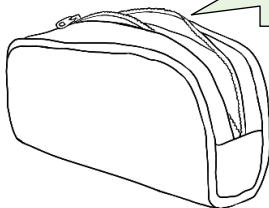



\$10

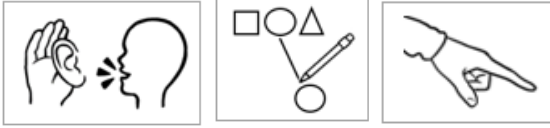



How many dollars?

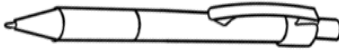

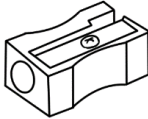
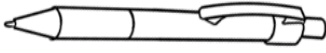
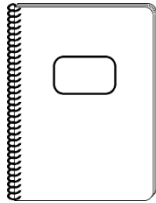
1.	 \$2  + \$3 <hr style="width: 150px; margin-left: 40px;"/> \$5
2.	 \$2  + \$4 <hr style="width: 150px; margin-left: 40px;"/> \$6
3.	 \$3  + \$5 <hr style="width: 150px; margin-left: 40px;"/> \$8





Do you have a pen?

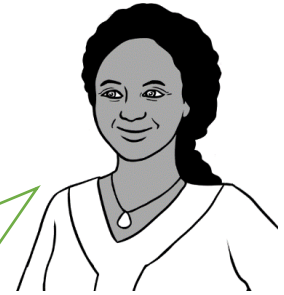

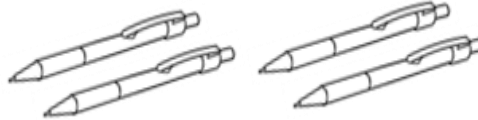

Yes. I have 4 pens.

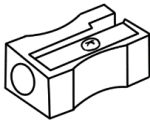
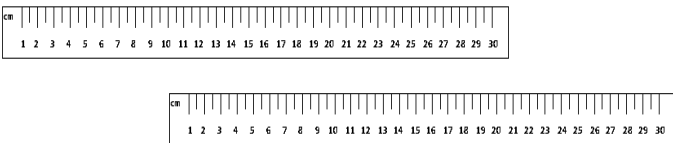
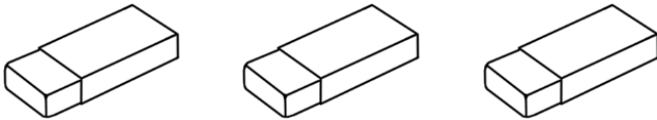
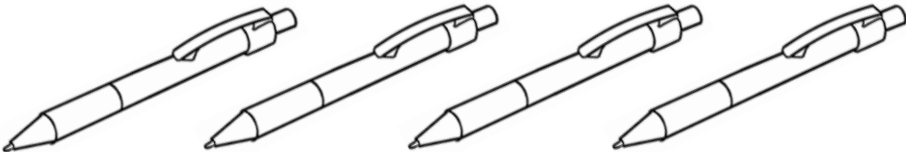
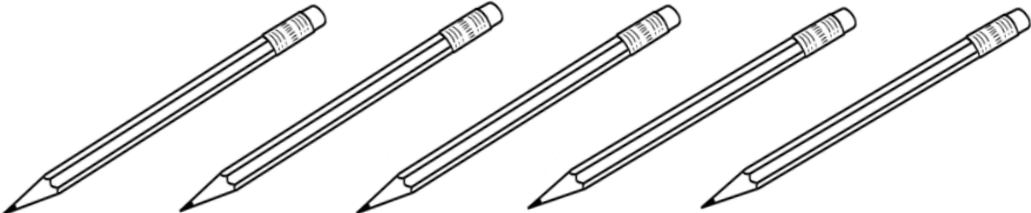

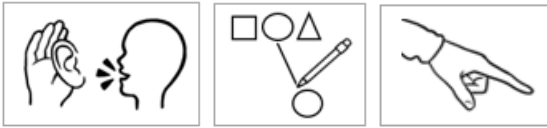
	1
	2
	3
	4
	5

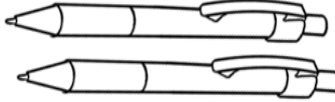
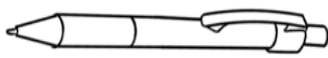

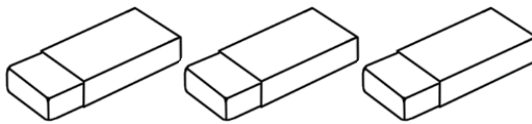
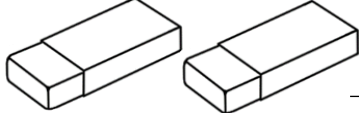
1.	 2  + 1 <hr style="width: 100px; margin-left: auto; margin-right: 0;"/> 3
2.	 2  + 2 <hr style="width: 100px; margin-left: auto; margin-right: 0;"/> 4
3.	 3  + 2 <hr style="width: 100px; margin-left: auto; margin-right: 0;"/> 5

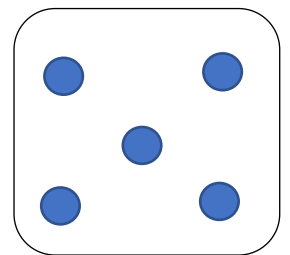
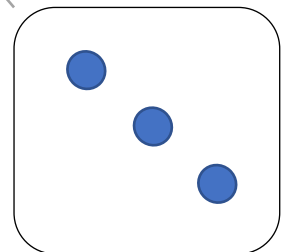
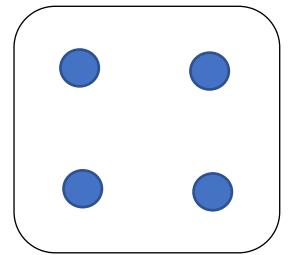

5 Numbers 1 - 12

1.

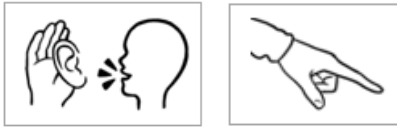

1	2	3	4	5
6	7	8	9	10
11	12			

2.

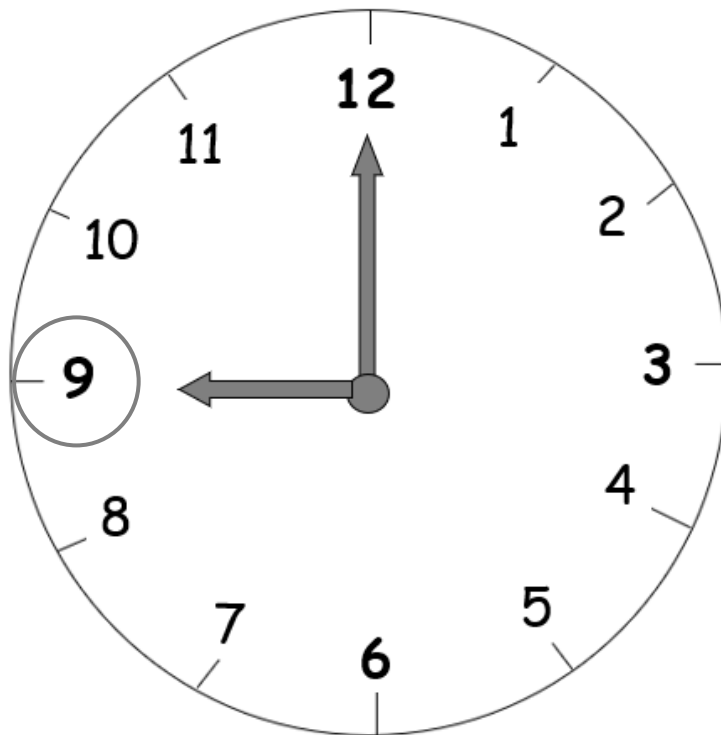

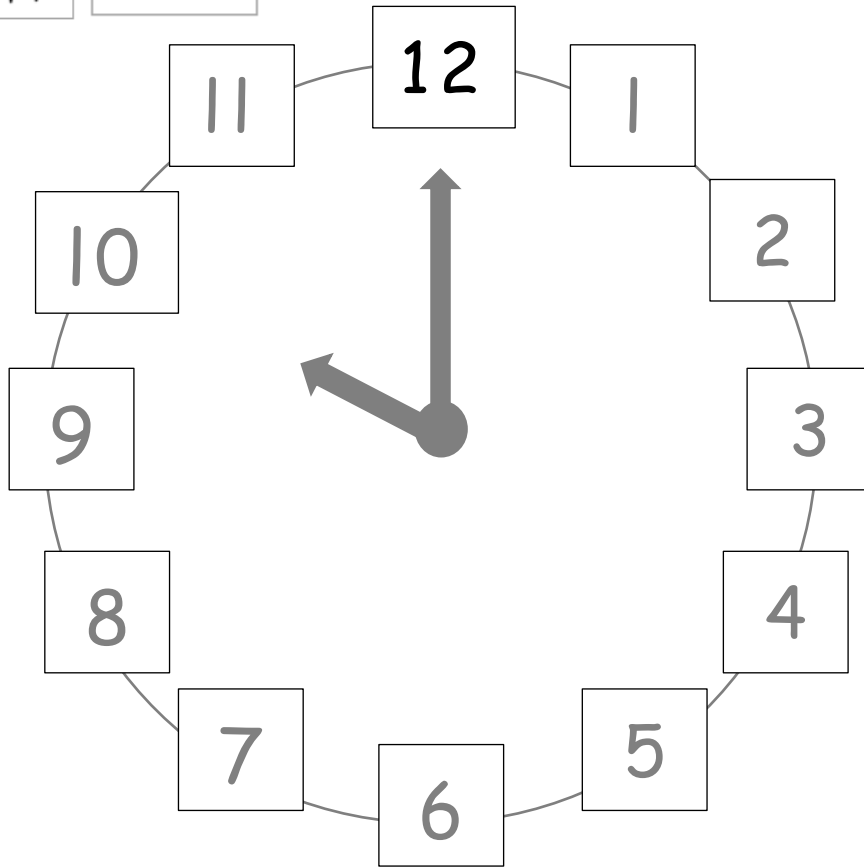

1	2	3	4	5	6
1					
7	8	9	10	11	12



1.



What is the time?



9 o'clock

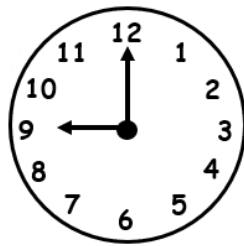

2.

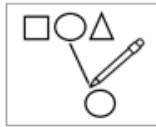

1 o'clock

2 o'clock

3 o'clock

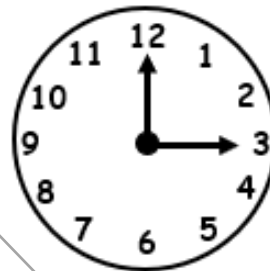

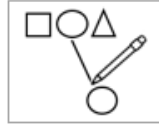

What is the time?



4 o'clock	
5 o'clock	
6 o'clock	
7 o'clock	
8 o'clock	
9 o'clock	

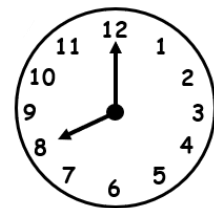
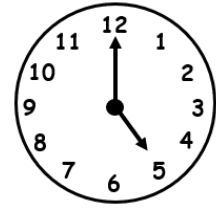

6 Numbers 1 - 20

1.



1	2	3	4	5
6	7	8	9	10
11	12	13	14	15
16	17	18	19	20

2.



11 12 13 14 15

11

16 17 18 19 20

1.

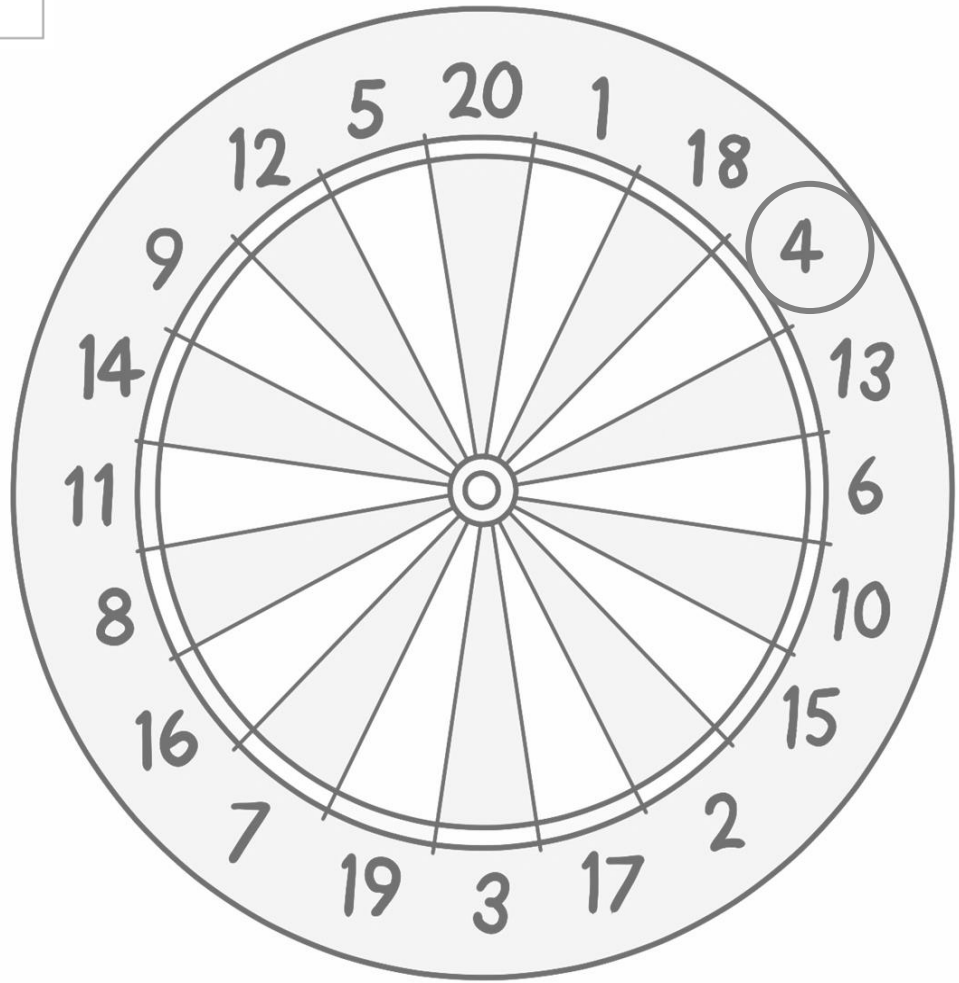
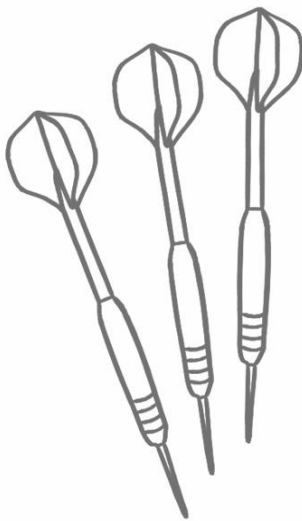

2.



11

12

13

14

15

--	--	--	--	--

16

17

18

19

20

--	--	--	--	--



0

1 2 9 6 7

4 3 4 5 8

5 6 9

6 7

12 10 5

14 13

12 11

15 13

16 18 7 9

14

17 18 17 6

15

8 19 2

5 16

20



1	2	3	4	5
1				

6	7	8	9	10

11	12	13	14	15

16	17	18	19	20

7 Numbers 1 - 30

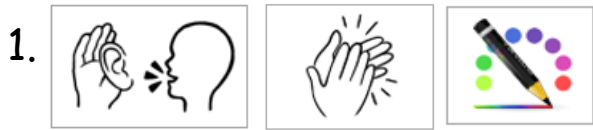

1	2	3	4	5
6	7	8	9	10
11	12	13	14	15
16	17	18	19	20
21	22	23	24	25
26	27	28	29	30

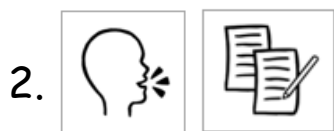

21	22	23	24	25
26	27	28	29	30



0

1 2 3 4 7

4 7 6 5 8

9 8 9

16 7

10 11 10 5

19

12 16 17

15 13 15 18

14 9 19

17

24 23 22 21 20

25

28 29 21 27

26 27

30

1.



April						
Mon	Tues	Wed	Thurs	Fri	Sat	Sun
		1	2	3	4	5
6	7	8	9	10	11	12
13	14	15	★ 16	17	18	19
20	21	22	23	24	25	26
27	28	29	30			

This is my son's birthday.

2.



before	birthday ★	after
15	16	17

1.



May						
Mon	Tues	Wed	Thurs	Fri	Sat	Sun
				1	2	3
4	5	6	7	8	9	10
11	12	13	14	15	16	17
18	19	20	21	22	23	24
25	26	27	28	29	30	31

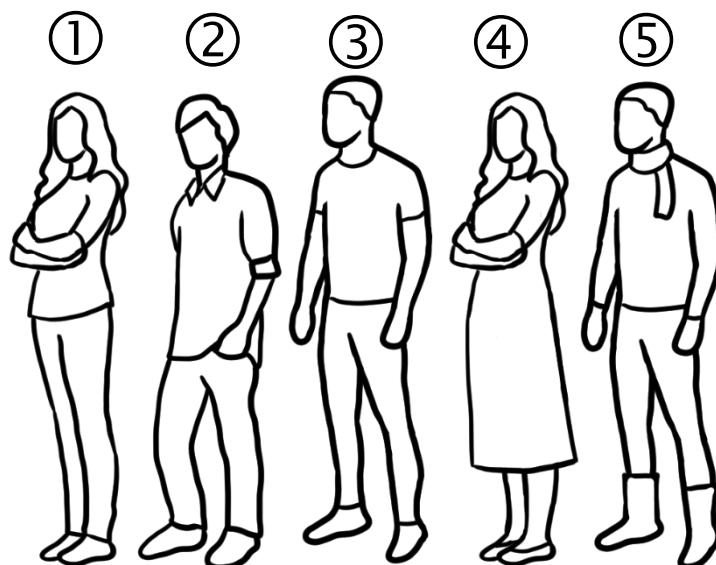

2.





8 Numbers 1 - 50



1	2	3	4	5
6	7	8	9	10
11	12	13	14	15
16	17	18	19	20
21	22	23	24	25
26	27	28	29	30
31	32	33	34	35
36	37	38	39	40
41	42	43	44	45
46	47	48	49	50



13	 
-----------	---

30	 
-----------	---

14	 
-----------	---

40	 
-----------	---

15	 
-----------	---

50	 
-----------	---



13
13

30

14

40



15

50



How many cents?



			
5	10	20	50
5			

1.

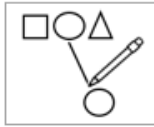

50 cents



5 cents



10 cents



20 cents

2.





			
5	10	20	50
5			



How many dollars?



	\$1	one dollar
	\$2	two dollars
	\$5	five dollars
	\$10	ten dollars
	\$20	twenty dollars
	\$50	fifty dollars

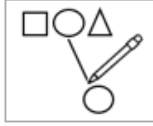

\$1
\$ ___



\$2
\$ ___



\$5
\$ ___



\$10
\$ ___



\$20
\$ ___



\$50
\$ ___







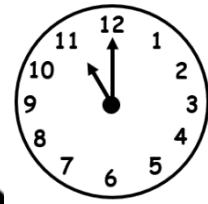



It is break time.

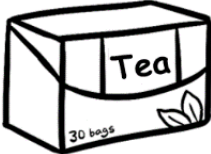

Tea or coffee?

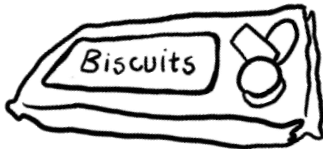

 <p>milk</p>   <p>tea</p>	
  <p>coffee</p>  <p>sugar</p>  <p>biscuits</p>	 

1.

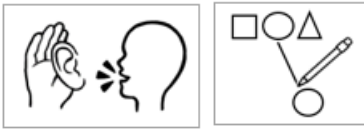



My shopping list





2.



Supermarket 

\$12 

\$4 

\$2 

\$5 

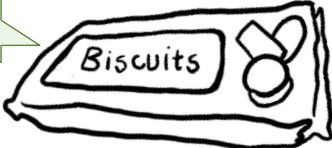
\$3 

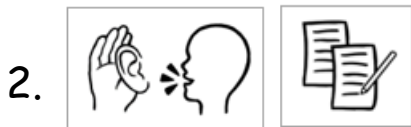

Supermarket		
	milk	\$ 2
	tea	\$ 4
	coffee	\$ 12
	sugar	\$ 5
	biscuits	\$ 3
TOTAL		\$ 26



\$ 26
\$ _____

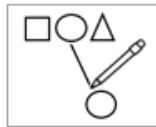

\$ 13
\$ ____



\$ 30
\$ ____



\$ 14
\$ ____



\$ 40
\$ ____



\$ 15
\$ ____



\$ 50
\$ ____



Bills

1.



How much is it?





Electricity Account

Mrs Z Tun
4/50 Baker Road
Kellivale
NSW

Customer Number **642-5693**

Due Date **15 June 2023**

Amount Due **\$46.00**

2.



\$46.00	\$46.00	\$46.00
\$<u>4</u>6.00	\$<u> </u>.00	<u> </u>46.<u> </u>

3.   

How much is it?





Gas Account

Customer Number **776-3085**

Mrs J Desta
56 North Street
Kellivale
NSW

Due Date **27 May 2023**

Amount Due **\$32.00**

4.     

\$ 32.00	\$ 32.00	\$ 32.00
\$ <u>3</u>2.00	\$ <u> </u>.00	<u> </u>32.<u> </u>

9 My numbers

Phone numbers

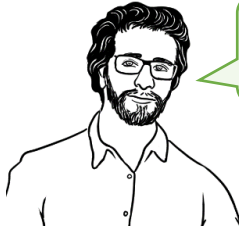

What is your phone number Rahim?



0469 883 412

0	4	6	9	8	8	3	4	1	2



Colour the numbers in Rahim's phone number.

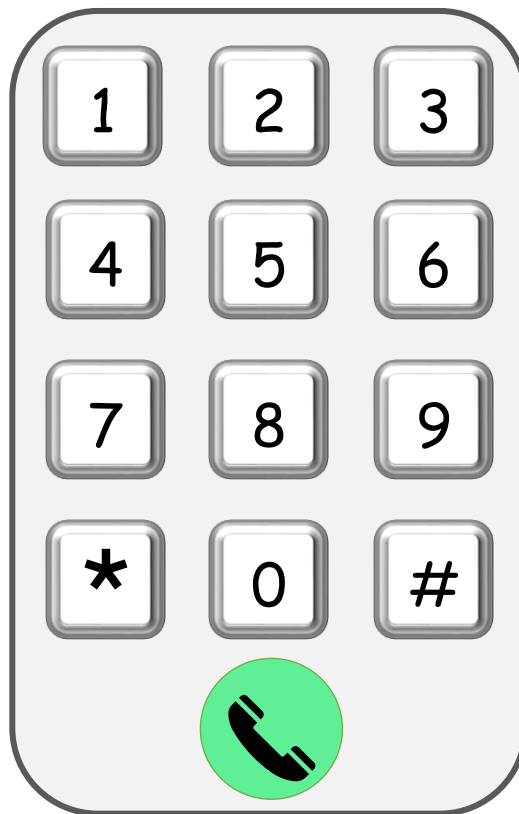



Ming's phone number

0	1	2	3	4	5	6	7	8	9
---	---	---	---	---	---	---	---	---	---

--	--	--	--	--	--	--	--	--	--



Jamila's phone number

0	1	2	3	4	5	6	7	8	9
---	---	---	---	---	---	---	---	---	---

--	--	--	--	--	--	--	--	--	--



Zarni's phone number

0	1	2	3	4	5	6	7	8	9
---	---	---	---	---	---	---	---	---	---

--	--	--	--	--	--	--	--	--	--



What is **your** phone number?

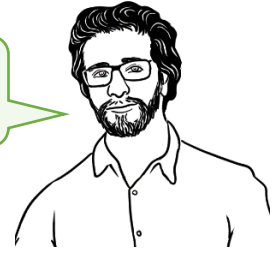

1.



My phone number is

--	--	--	--	--	--	--	--	--	--	--

--	--	--	--	--	--	--	--	--	--	--

2.

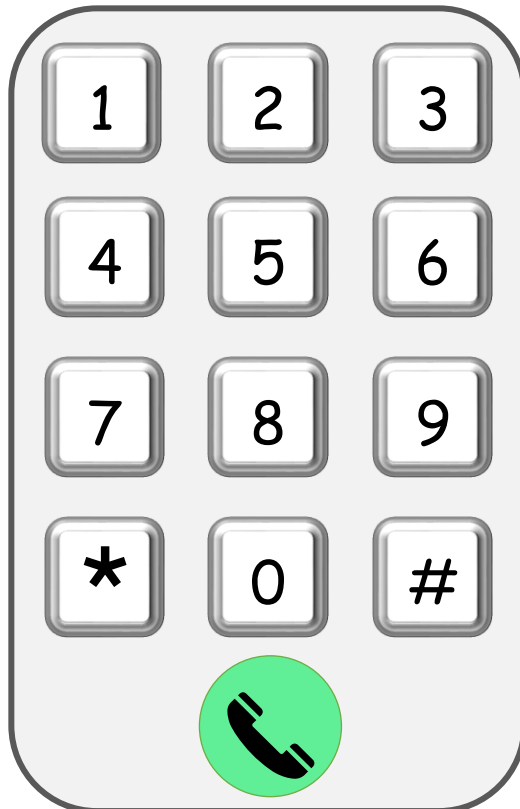



My teacher's phone number

0	1	2	3	4	5	6	7	8	9
---	---	---	---	---	---	---	---	---	---

--	--	--	--	--	--	--	--	--	--

My school phone number

0	1	2	3	4	5	6	7	8	9
---	---	---	---	---	---	---	---	---	---

--	--	--	--	--	--	--	--	--	--

My emergency phone number

0	1	2	3	4	5	6	7	8	9
---	---	---	---	---	---	---	---	---	---

--	--	--	--	--	--	--	--	--	--

1.



Address



What is your address Zarni?

Unit 4,
50 Baker Road
Kellivale



2.

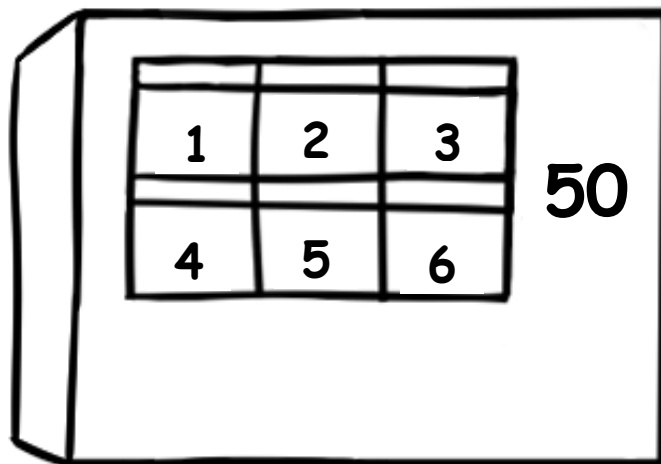



Zarni's address

Number and Street	4 / 50 Baker Road
Suburb	Kellivale
Postcode	2421



What is **your** address?



My address

Number and Street	
Suburb	
Postcode	

1.



Date of birth



What is your date of birth Zarni?



10 April 1978

2.



1	January
2	February
3	March
4	April
5	May
6	June

7	July
8	August
9	September
10	October
11	November
12	December



This is my date of birth.



10 April 1978

10 - 04 - 1978	10 / 04 / 1978
___ - 04 - ___	___ / ___ / ___

What is your date of birth?

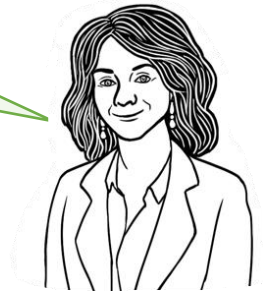

My date of birth

___ - ___ - ___	___ / ___ / ___
-----------------	-----------------

___ - ___ - ___	___ / ___ / ___
-----------------	-----------------

Age



How old is your baby?

4 months old.



22 24

1.



San is _____ years old.

35 45

2.



Zarni is _____ years old.

19 22

3.



Rahim is _____ years old.

48 50

4.



Jamila is _____ years old.

ImmiCard





1.   



I have an ImmiCard.

Australian Migration Status
Australian Government ImmiCard





AM6249377

Surname
TUN

Given Names
ZARNI

Date of Birth
10-04-1978

ImmiCard

ImmiCard No
AM6249377

2.  

Zarni's date of birth

10 - 04 - 1978	10 / 04 / 1978
____ - 04 - ____	____ / ____ / ____

Medicare Card

1.  

I have a Medicare card.



medicare

3075 26984 1

1 Zarni Tun

VALID to **06/2031**

2.  

This is my Medicare number.



3	0	7	5	2	6	9	8	4	1